

Features:

- ☞ Up to 1.25Gb/s Data Links
- ☞ Hot-Pluggable
- ☞ Single LC connector
- ☞ Up to 80 km on 9/125μm SMF
- ☞ 1310nm/1550nm DFB laser transmitter
- ☞ 1310nm/1550nm PIN photo-detector
- ☞ Single +3.3V Power Supply
- ☞ Monitoring Interface Compliant with SFF-8472
- ☞ Operating temperature range: -40°C to 85°C/-5°C to 85°C/-0°C to 70°C
- ☞ RoHS compliant and Lead Free

Applications:

- ☞ 1.25 Gb/s 1000Base-ZX Ethernet
- ☞ Fiber Channel
- ☞ Metro/Access Networks
- ☞ Other Optical Link

Specification:

● Electrical and Optical Characteristics: (Condition: $T_a=T_{OP}$)

Parameter	Symbol	Min.	Typical	Max.	Unit
Transmitter Differential Input Voltage	+/-TX_DAT	200		2400	mV p-p
Supply Current	I _{CC}		130	180	mA
Tx_Disable Input Voltage – Low	V _{IL}	0		0.8	V
Tx_Disable Input Voltage – High	V _{IH}	2.0		V _{CC}	V
Tx_Fault Output Voltage – Low	V _{OL}	0		0.8	V
Tx_Fault Output Voltage – High	V _{OH}	2.0		V _{CC}	V
Receiver Differential Output Voltage	+/-RX_DAT	600		1400	mV p-p
Rx_LOS Output Voltage- Low	V _{OL}	0		0.8	V
Rx_LOS Output Voltage- High	V _{OH}	2.0		V _{CC}	V

Transmitter: TM-466PS-843E(I)

Parameter	Symbol	Min.	Typical	Max.	Unit
Data Rate	B	-	1250	-	Mb/s
Centre Wavelength	λ_c	1480	1490	1500	nm
Output Spectral Width	$\Delta\lambda$	-	-	1	nm
Average Output Power	P _o	-2	-	+3	dBm
Extinction Ratio	EXT	9	-	-	dB
Data Input Voltage-High	V _{IHS}	V _{CC} -1.16	-	V _{CC} -0.89	V
Data Input Voltage -Low	V _{ILS}	V _{CC} -1.82	-	V _{CC} -1.48	V
Supply Current	I _{CC}	-	90	150	mA

Output Optical Eye	Compliant with IEEE802.3Z				
Receiver: TM-466PS-843E(I)					
Parameter	Symbol	Min.	Typical	Max.	Unit
Receive Sensitivity	P_{min}	-	-	-24	dBm
Maximum Input Power	P_{MAX}	-3	-	-	dBm
Signal Detection-Asserted	SD_{HIGH}	-	-	-24	dBm
Signal Detection-Deserted	SD_{LOW}	-34	-	-	dBm
Hysteresis	-	-	3.0	-	dBm
Output High Voltage	V_{OH}	$V_{cc}-1.03$	-	$V_{cc}-0.89$	V
Output Low Voltage	V_{OL}	$V_{cc}-1.82$	-	$V_{cc}-1.63$	V
Operating Wavelength	λ_c	1540	1550	1560	nm
Supply Current	I_{CC}	-	80	110	mA
Transmitter: TM-466SP-843E(I)					
Parameter	Symbol	Min.	Typical	Max.	Unit
Data Rate	B	-	1250	-	Mb/s
Centre Wavelength	λ_c	1540	1550	1560	nm
Output Spectral Width	$\Delta \lambda$	-	-	1	nm
Average Output Power	P_o	-2	-	-	dBm
Extinction Ratio	EXT	9	-	-	dB
Data Input Voltage-High	V_{IHS}	$V_{cc}-1.16$	-	$V_{cc}-0.89$	V
Data Input Voltage -Low	V_{ILS}	$V_{cc}-1.82$	-	$V_{cc}-1.48$	V
Supply Current	I_{CC}	-	90	150	mA
Output Optical Eye	Compliant with IEEE802.3Z				
Receiver: TM-466SP-843E(I)					
Parameter	Symbol	Min.	Typical	Max.	Unit
Receive Sensitivity	P_{min}	-	-	-23	dBm
Maximum Input Power	P_{MAX}	-3	-	-	dBm
Signal Detection-Asserted	SD_{HIGH}	-	-	-24	dBm
Signal Detection-Deserted	SD_{LOW}	-34	-	-	dBm
Hysteresis	-	-	3.0	-	dBm
Output High Voltage	V_{OH}	$V_{cc}-1.03$	-	$V_{cc}-0.89$	V
Output Low Voltage	V_{OL}	$V_{cc}-1.82$	-	$V_{cc}-1.63$	V
Operating Wavelength	λ_c	1480	1490	1500	nm
Supply Current	I_{CC}	-	80	110	mA

● **Absolute Maximum Ratings: (T_C=25°C)**

Parameter	Symbol	Min.	Max.	Unit
Storage Temperature	T _{ST}	-40	+85	°C
Operating Temperature	T _{IP}	0(-40)	+70(+85)	°C
Input Voltage	T _{CC}	0	+5	V

● **Recommended Operating Environment:**

Parameter	Symbol	Min.	Typical	Max.	Unit
Supply Voltage	V _{CC}	+3.0	+3.3	+3.6	V
Operating Temperature	T _{OP}	0(-40)	-	+70(+85)	°C

● **Timing Characteristics:**

Parameter	Symbol	Min.	Typical	Max.	Unit
TX_DISABLE Assert Time	t _{off}		3	10	usec
TX_DISABLE Negate Time	t _{on}		0.5	1	msec
Time to Initialize Include Reset of TX_FAULT	t _{int}		30	300	msec
TX_FAULT from Fault to Assertion	t _{fault}		20	100	usec
TX_DISBEL Time to Start Reset	t _{reset}	10			usec
Receiver Loss of Signal Assert Time (Off to On)	T _{A,RX_LOS}			100	usec
Receiver Loss of Signal Assert Time (On to Off)	T _{d,RX_LOS}			100	usec

● **Serial ID Memory Contents:**

Data Address	Length (Byte)	Name of Length	Description and Contents
Base ID Fields			
0	1	Identifier	Type of Serial transceiver (03h=SFP)
1	1	Reserved	Extended identifier of type serial transceiver (04h)
2	1	Connector	Code of optical connector type (07=LC)
3-10	8	Transceiver	Gigabit Ethernet 1000Base-SX & Fiber Channel
11	1	Encoding	8B10B (01h)
12	1	BR,Nominal	Nominal baud rate, unit of 100Mbps
13-14	2	Reserved	(0000h)
15	1	Length(9um)	Link length supported for 9/125um fiber, units of 100m
16	1	Length(50um)	Link length supported for 50/125um fiber, units of 10m
17	1	Length(62.5um)	Link length supported for 62.5/125um fiber, units of 10m
18	1	Length(Copper)	Link length supported for copper, units of meters
19	1	Reserved	
20-35	16	Vendor Name	SFP vendor name
36	1	Reserved	
37-39	3	Vendor OUI	SFP transceiver vendor OUI ID
40-55	16	Vendor PN	Part Number

56-59	4	Vendor rev	Revision level for part number
60-62	3	Reserved	
63	1	CCID	Least significant byte of sum of data in address 0-62
Extended ID Fields			
64-65	2	Option	Indicates which optical SFP signals are implemented (001Ah = LOS, TX_FAULT, TX_DISABLE all supported)
66	1	BR, max	Upper bit rate margin, units of %
67	1	BR, min	Lower bit rate margin, units of %
68-83	16	Vendor SN	Serial number (ASCII)
84-91	8	Date code	Manufacturing date code
92-94	3	Reserved	
95	1	CCEX	Check code for the extended ID Fields (addresses 64 to 94)
Vendor Specific ID Fields			
96-127	32	Readable	specific date, read only

Block Diagram of Transceiver:

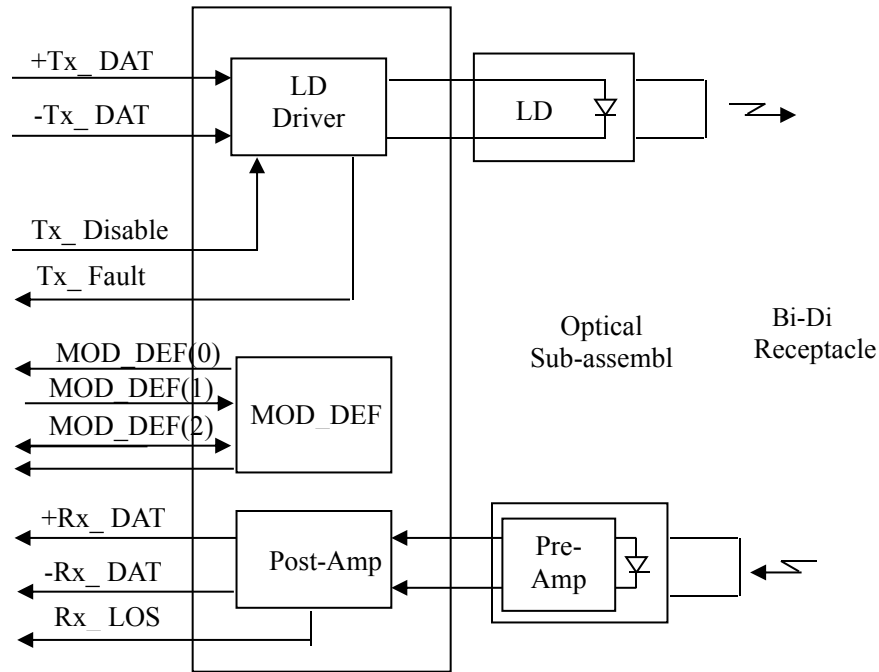

Pin Assignment:

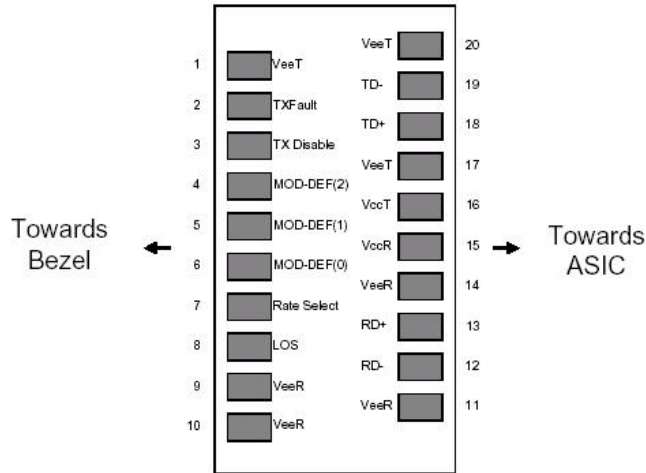

Pin out of Connector Block on Host Board

Pin Description:

Pin	Symbol	Name/Description	Ref.
1	V _{EET}	Transmitter Ground (Common with Receiver Ground)	1
2	T _{FAULT}	Transmitter Fault. Not supported.	
3	T _{DIS}	Transmitter Disable. Laser output disabled on high or open.	2
4	MOD_DEF(2)	Module Definition 2. Data line for Serial ID.	3
5	MOD_DEF(1)	Module Definition 1. Clock line for Serial ID.	3
6	MOD_DEF(0)	Module Definition 0. Grounded within the module.	3
7	Rate Select	No connection required	
8	LOS	Loss of Signal indication. Logic 0 indicates normal operation.	4
9	V _{EER}	Receiver Ground (Common with Transmitter Ground)	1
10	V _{EER}	Receiver Ground (Common with Transmitter Ground)	1
11	V _{EER}	Receiver Ground (Common with Transmitter Ground)	1
12	RD-	Receiver Inverted DATA out. AC Coupled	
13	RD+	Receiver Non-inverted DATA out. AC Coupled	
14	V _{EER}	Receiver Ground (Common with Transmitter Ground)	1
15	V _{CCR}	Receiver Power Supply	
16	V _{CCT}	Transmitter Power Supply	
17	V _{EET}	Transmitter Ground (Common with Receiver Ground)	1
18	TD+	Transmitter Non-Inverted DATA in. AC Coupled.	
19	TD-	Transmitter Inverted DATA in. AC Coupled.	
20	V _{EET}	Transmitter Ground (Common with Receiver Ground)	1

Notes:

1. Circuit ground is internally isolated from chassis ground.
2. Laser output disabled on TDIS >2.0V or open, enabled on TDIS <0.8V.
3. Should be pulled up with 4.7k – 10kohms on host board to a voltage between 2.0V and 3.6V. MOD_DEF(0) pulls line low to indicate module is plugged in.
4. LOS is open collector output. Should be pulled up with 4.7k – 10kohms on host board to a voltage between 2.0V and 3.6V. Logic 0 indicates normal operation; logic 1 indicates loss of signal.

Mechanical Dimensions:

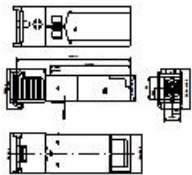
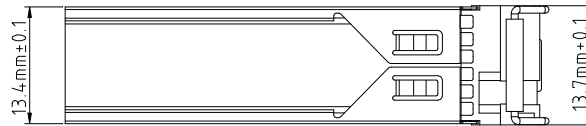
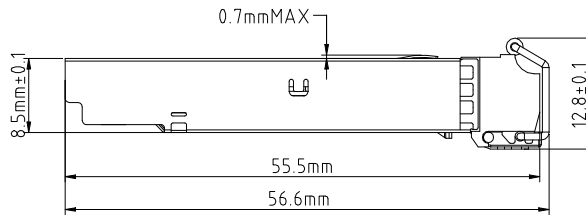
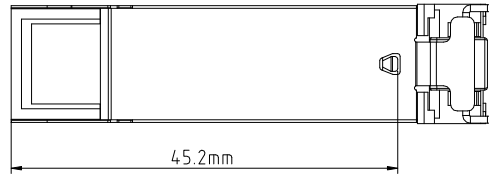
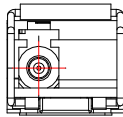
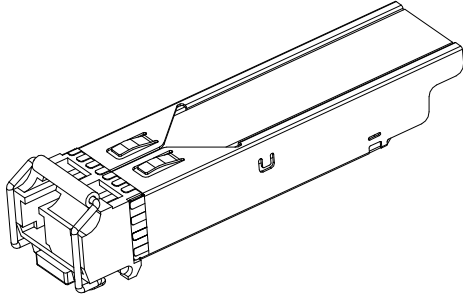

Recommended Circuit:

